

UNIT 4: ELECTRICITY

Electricity is a form of energy that can be easily changed to other forms.

Where does Electricity come from?

Mainly 2 sources:

- 1) Power Stations - Supply a lot of electricity - Used in many electrical appliances
- 2) Electric Cells (batteries) - Supply a little electricity - Portable - Safe

How does an Electrical Appliance Work?

To make an electrical appliance work, electricity must flow through it.

The flow of electricity is called an electric current. The path along which the electric current moves is called the electric circuit.

What is an Electric Current?

An electric current is the rate of flow of electric charges in a circuit.

Electric Charges

Electric charges are made up of positive charges (protons) and negative charges (electrons). When these charges flow in a circuit, a current is produced.

How does electricity flow?

The battery in a circuit gives energy to the electrons and pushes them around a circuit, from the negative terminal of the cell, round the circuit and back to the positive terminal of the cell.

How to Measure Current?

The SI unit for electric current is ampere (A). Smaller currents are measured in milliamperes (mA).

$1\text{ A} = 1000\text{ mA}$ $1\text{ mA} = 0.001\text{A}$ Different electrical components and appliances require different sizes of current to turn them on.

Instrument to Measure Current

An ammeter is an instrument used for measuring electric current.

Ammeter

It must be connected in series in the circuit. Positive side of ammeter must be connected nearest to the positive terminal of the battery (electric cell), and vice versa.

Electric Circuits







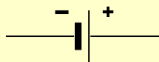

Electric circuits are made up of electrical components. These components must be joined together without any gap in between to form a closed circuit.

Incomplete circuits are called open circuits.

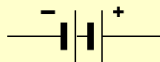
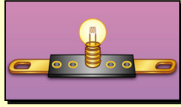

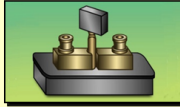
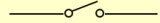
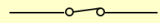

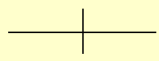
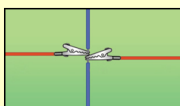

Both the circuits in the diagram are incomplete, hence they are known as “open circuits”.



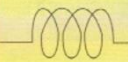

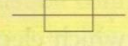

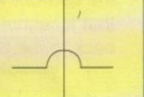
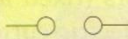



An electric current flows only when there is: a source of electrical energy and a closed circuit.

How to draw Circuit Diagrams

Component	Symbol	Component	Symbol
 An electric cell		 Battery	
 Light bulb (lamp)		 Switch	 Switch (open)  Switch (closed)
 Connecting wires (not joined)		 Connecting wires (joined)	

Symbols are used to represent the various electrical components in circuits.

Symbol	Electrical component	Symbol	Electrical component	Symbol	Electrical component
	Battery (a few electric cells in series)		Magnetising coil or inductor		Voltmeter
	Wires joined at a junction	 or 	Fuse		Millivoltmeter
	Wires crossed over each other but not joined		Power supply		Bell

Symbol	Electrical component	Symbol	Electrical component	Symbol	Electrical component
	Switch (open)		Lamp	 or 	Galvanometer
	Switch (closed)		Fixed resistor		Ammeter
	Electric cell		Variable resistor (or rheostat)		Milliammeter

Switches

A switch is used to open or close a circuit.

Circuit diagrams for open and closed circuits

Series and Parallel

There are 2 ways in which an electric circuit can be arranged:

1. Series
2. Parallel

Series Circuit

- A series circuit connects the components one after the other.
- A single loop is formed
- A break in any part of a series circuit stops the flow of current in the whole circuit.

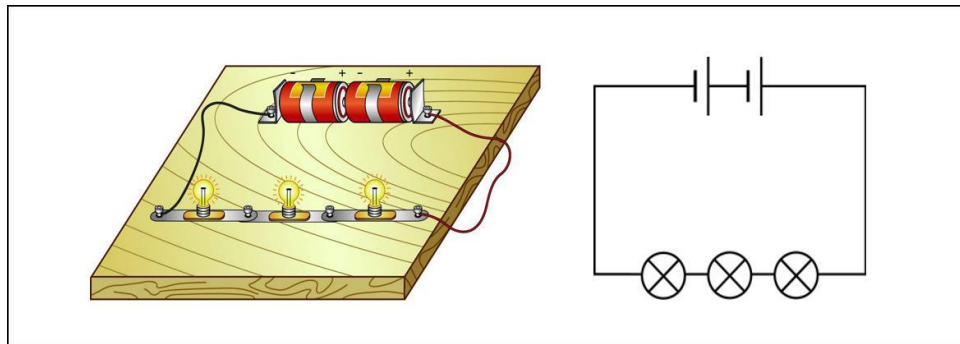

Parallel Circuit

- A parallel circuit divides into two or more branches.
- The current divides and flows through each parallel branch.
- If a component breaks or is removed, the other components remain on.

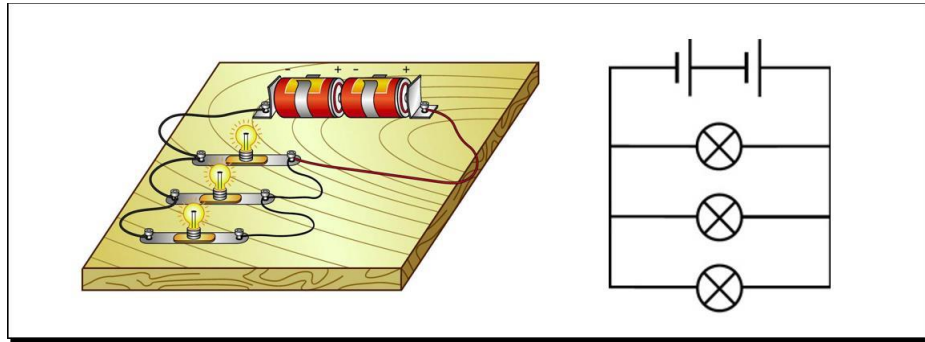

Voltage

An electric cell gives energy to the electrons and pushes them round a circuit. Voltage is a measure of how much energy the electrons receive. Different voltages are supplied by different cells and batteries.

How to Measure Voltage?

The SI unit for voltage is volt (V). A voltmeter is an instrument used for measuring voltages.

Voltmeter

Voltmeters must be connected in parallel to the circuit. The positive side of voltmeter is connected to the positive terminal of the cell, and vice versa.

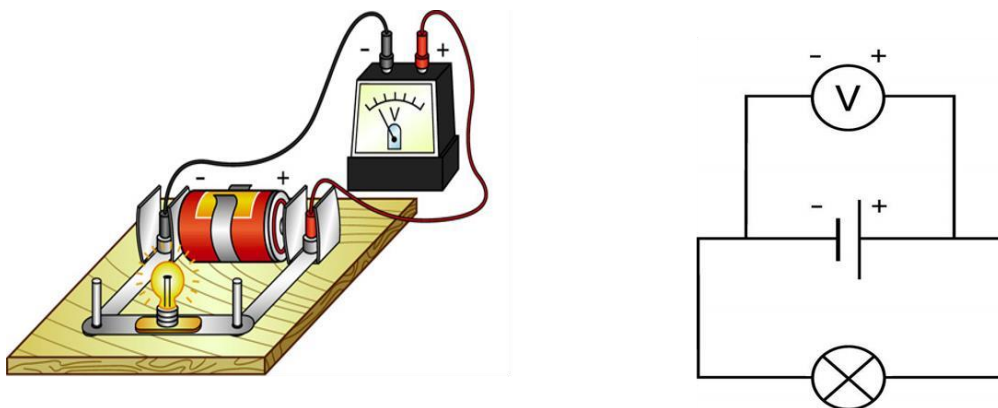

Electromotive Force (e.m.f)

- Electromotive force is the same as voltage.
- E.m.f refers to the amount of energy supplied by the electric source (eg. battery) to each unit of electric charge.
- E.m.f is also measured by a voltmeter

Electromotive Force (e.m.f)

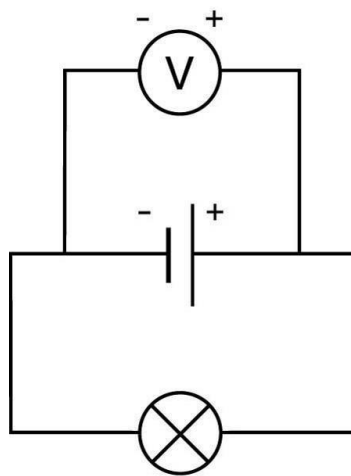

Potential Difference (P.D.)

High to Low Electric charges will flow from a point of higher potential (energy) to lower potential. This difference in electric potential between 2 points in a circuit is known as the potential difference. It is the same as VOLTAGE also.

Resistance

When an electric current flows through a circuit, there will be some resistance that opposes it. (similar to friction) It can be measured by dividing voltage by the current.

R = Resistance
V = Voltage
I = Current

Resistance

- Good conductors of electricity have LOW RESISTANCE. (Eg. Metal objects)
- Electricity is able to flow through them very easily
- Poor conductors of electricity have HIGH RESISTANCE. (Eg. Wood, cloth)
- Electricity is not able to flow through them easily
- The SI unit for resistance is ohm.
- Different electrical components have different resistance
- For example, nichrome wires have a higher resistance than copper wires.

Resistors

An electrical component that is specially made to have a certain resistance is called a resistor. They can be connected in a circuit to resist the current flow.

Fixed Resistors and Variable Resistors

Fixed resistors have only one resistance value Variable resistors can be adjusted to change the resistance.

AC & DC System

There are two systems of electric generation and supply, Direct current or DC. Alternating current or AC. Direct Current: it is the kind of electric current that may or may not change the magnitude but the direction of the current will never change. E.g. Cells, Batteries and DC Generator.

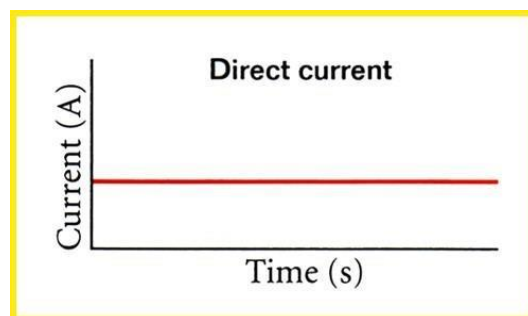

Alternating Current: it is the kind of electric current, which not only changes its magnitude but also its sign as time passes, in a definite manner. This is the current that is supplied by Power station for domestic and commercial use. Max. voltage is known as Amplitude.

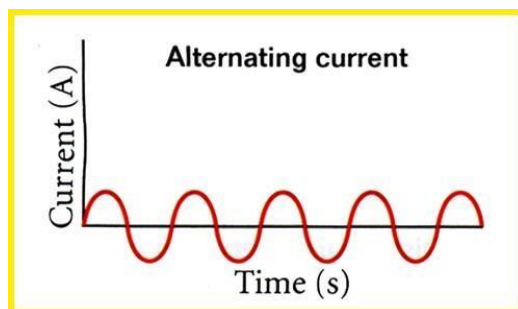

3 Pin Plug

- The live wire carries current to the appliance at a high voltage.
- The neutral wire completes the circuit and carries current away from the appliance.
- The third wire, called the earth wire (green/yellow) is a safety wire and connects
- the metal case of the appliance to the earth.
- A fuse is nothing more than a short length of wire designed to melt and
- separate in the event of excessive current.
- Fuses are always connected in series with the component(s) to be protected from overcurrent, so that when the fuse blows (opens) it will open the entire circuit and stop current through the component(s).

SHORT CIRCUIT

- Short circuit occurs when a live conductor comes in direct contact with the neutral or earth conductor.
- A very low resistance path is provided to the current.
- The current then does not pass through the appliance but a heavy current pass through the wires of the circuit directly bypassing the appliance circuit.
- When current passes through the appliance, the appliance offers resistance to the current thus reducing its magnitude.

- Since the resistance is bypassed, a huge current flows through the circuit and normally the fuse blows off or the MCB switches off and the appliance is saved.
- Short circuit can occur inside an appliance or in the wiring system when a live wire comes in direct contact of the neutral wire.

FUSE

- Fuses are a very important part of any electrical system.
- Fuses are special devices that can be inserted in the circuit and consist of wires of low melting point.
- Whenever current through a part of the circuit becomes very high, the wires in the circuit get heated.
- The fuse material having low melting point melts quickly and snaps the circuit, thus, stopping the current flow before further heating could melt the whole wiring system and cause a possible fire.
- Hence, FUSE IS A DEVICE WHICH CUTS OFF THE CIRCUITS WHEN MORE THAN THE PREDETERMINED VALUE OF CURRENT FLOWS IN A CIRCUIT.
- The std. fuse sizes are:
 - 2 amps – 480 W
 - 5 amps – 1200 W
 - 10 amps – 2400 W
 - 13 amps – 3120 W

Types of Fuse

Semi enclosed fuse or re-wireable fuse or Kit Kat fuse Unit:

- This kind of fuse is most commonly used in the case of domestic wiring and small-scale usage. Another name for this type is the KIT-KAT type fuse. The main composition is of a porcelain base which holds the wires.
- The fuse element is located inside a carrier that is also made out of porcelain. It is possible for you to remove the fuse carrier without any risk of electrical shock. Normally what happens is that when the fuse blows, you can replace it without having to change the complete thing.
- The main metals or alloys used in making fuse wire include lead, tinned copper, aluminium or tin lead alloy.

Cartridge Fuse:

- Cartridge fuse as the name implies, has a shape similar to the cartridge of a bullet.
- In a cartridge – type fuse, the fuse wire is enclosed in a tube bulb or in a case and the whole unit is sealed off.
- In case the fuse blows out due to some fault or overload, it is replaced by a fresh unit as the cartridge cannot be replaced.

HRC fuse or high rupturing capacity fuse:

- In that type of fuse, the fuse wire or element can carry short circuit heavy current for a known time period. During this time if the fault is removed, then it does not blow off otherwise it blows off or melts.
- It is similar in construction to a cartridge type fuse.
- If the short circuit is rectified on time the fuse won't blow off, otherwise it blows off and breaks the continuity of the circuit.

MCB - Miniature Circuit Breaker:

- A miniature circuit breaker automatically switches off the current instantly if there is a short circuit or power overload.
- It prevents damage to expensive wiring and the risk of fire.
- Supply is restored by manually switching it 'ON' again after the fault is rectified.
- Many houses, factories and plants have installed MCB's replacing the earlier used fuse.

Earthing

- Connecting outer metal cover of electrical appliances to the earth with a wire is known as earthing.
- Below are the basic needs of Earthing.
- To protect human lives as well as provide safety to electrical devices and appliances from leakage current.

- To keep voltage as constant in the healthy phase (If fault occurs on any one phase).
- To Protect Electric system and buildings form lighting.
- To avoid the risk of fire in electrical installation systems.
- Common methods of Earthing:
 - Plate
 - Pipe
 - Rod

Pipe Earthing

Electric Wires & Types of Wiring

- Wires are used for carrying current from one point in the circuit to another.
- To prevent accidents and fire hazards, wires must be coated with insulating material.
- The term cable is used for all heavy section insulated conductors.

Types of Wires

Vulcanized Indian Rubber (VIR):

- It consists of a copper wire covered with a layer of rubber insulation with a protective cotton braid over it.
- It is rarely used now since it absorbs moisture.
- Still used in hand held irons etc. Where maximum flexibility is required.
- When the rubber insulation melts its performance goes down.

Lead Alloy Sheathed Wires:

- Ordinary VIR cables and wires are unsuitable for damp conditions.
- In order to use VIR wires under damp conditions, a thin lead covering is made on them.
- These are expensive.

Cab type sheathed/ Tough Rubber Sheathed (CTS/TRS):

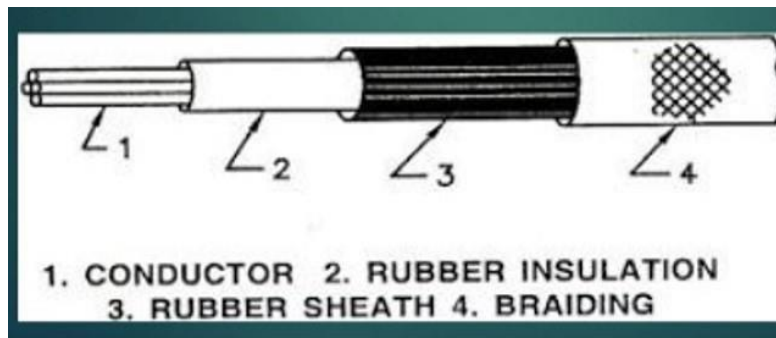

- These wires are somewhat moisture proof, because instead of vitrified rubber, they are covered with tough rubber compound.
- They are cheaper than lead sheathed wires.
- They are not affected by chemicals, water and steam.

Polyvinyl Chloride (PVC) wires:

- In this type of wires, bare conductors are insulated with PVC insulation.
- They are used in batten, conduit, cleat wiring used in domestic wiring system.

Laying Methods of Electrical Wiring

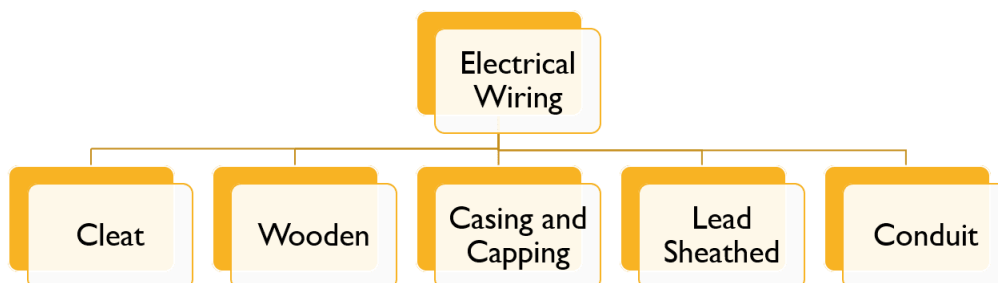

Cleat Wiring

- This type of wiring is suitable for temporary wiring purpose.
- The porcelain or wooden cleats are very easy to erect and fixed at a distance of 4 to 5 m apart.
- VIR or PVC wires are normally used in this system of wiring.
- Easy to dismantle and reusable.

Wooden Batten Wiring

- In such type of wiring either TRS or PVC wires are used.
- The wires are carried on wooden batten with clips.

Casing and Capping Wiring

- This is a very common type of wiring used for in door wiring.
- VIR wires are used and carried in PVC casing on the wall and closed by PVC covers called capping.
- They are costlier but more reliable and pleasing to look at.

Lead Sheathed Wiring

The metal sheath is provided over the insulated conductor in order to protect system from mechanical injury, dampness and atmospheric action. Same as C.T.S wiring system cables are run on wooden batten and are fixed with the help of tinned link clips.

Conduit Wiring

- Conduit Wiring System is best for domestic and coercial installations.
- It provides proper protection to the installation against fire hazards, shock, mechanical damage and dampness.
- The cable used in this system is either V.I.R or PVC insulated and is run in mild steel or PVC pipes called conduits.

- Conduits carrying the insulated wires can be installed on the surface of the walls or concealed in the walls and the ceiling.

Safety Precautions while handling Electrical Appliances

- Many accidents occur while working with electricity or handling electrical equipments. Most accidents happen due to ignorance of a few basic principal and some due to negligence.
- One should not temper unnecessarily with live electrical wires.
- The plug should not be disconnected by pulling the flexible wire off the socket.
- Before doing any work or replacing parts, always remember to put the main switch 'off'.
- Earthing should be kept in good condition.
- Live wire should always be connected through the switch.
- One should not use tools, such as knife, screw driver, etc. without handle otherwise it can injure the hand.
- In case of electrical wire water should not be poured to put off the fire.
- All fire extinguishers cannot be used for electrical fires; only CO₂ extinguishers are used for this purpose.
- Hands should not be wet while handling electrical appliances.
- One should wear rubber-sole footwear while handling electrical appliances.

Electric usage units

- Watt is the unit of power (symbol: W). One watt is defined as the energy consumption rate of one joule per second. $1W = 1J / 1s$.
- The kilowatt hour (symbolized kW) is a unit of energy consumption. $1kW = 1000 W$.
- Kilowatt hour is the basic unit of electricity (kWh). In simple terms, 1 kWh is the amount of energy used by a 1kW (1000 watt) of an electrical appliance for 1 hour.
- Horsepower (hp) is a measurement of a unit of power(electricity). It is equal to 746 watts.
- $1 hp = 746 W = 746/1000 = 0.746 kW$

ELECTRIC TARIFF CALCULATION

Find out the bill for the month of Jan. 2018 for the following load. Electricity charges for 1 kWh is Rs. 7. Meter rent is Rs. 250 per month

1hp = 746 watt = 0.746 kW Energy consumed = Power X Time

Energy consumed in kWh = power in watt X no. Of units X hours run in a day X no. of days in the month /1000. * If the power is given in kW, division by 1000 is not needed.

Calculation:

- Energy consumed by 100-watt lamps = $100 \times 12 \times 10 \times 30 / 1000 = 360$ kWh
- Energy consumed by 3 kW water heater = $3 \times 1 \times 5 \times 30 = 450$ kWh
- Energy consumed by 2hp motor = $1.492 \times 1 \times 2 \times 30 = 89.52$ kWh
- (1 hp = 746 watt = 0.746 kW)
- 2 hp = $2 \times 0.746 = 1.492$ kW)
- Total energy consumed = $360 + 450 + 89.52 = 899.52$ kWh
- Rate / unit is Rs. 7
- Amount of electricity charge = $899.52 \times 7 = \text{Rs. } 6296.64$
- TOTAL AMOUNT OF BILL = $6296.64 + 250 = \text{Rs. } 6546.64$

Illumination

Importance of Lighting in Hotels

- The hospitality industry is all about providing guests the very best for their pleasure. From the moment they walk in, every element, from the lobby to the dining's areas and rooms have been designed to create an immersive, relaxing experience.
- Most of the spaces are designed with a theme or ambiance in mind, and lighting, whether it's the more traditional grand chandeliers, to modern concealed lighting, all play a big role in enhancing the desired mood for the guests.
- Lighting in a hospitality space is complicated by the fact that different kinds of lights are needed in different areas. Specialist illumination engineers and architects are required to decide about the lighting aspects in different areas of the hotel.
- Lighting in a hotel should also ensure that the guest feels at home. Hence, it is imperative for lighting to be intelligent and to create a relaxing environment. Lighting control systems can alter intensities, lamp combinations and colours instantly.
- With miniature and highly-efficient LED light sources, one can create the right ambience in both white and coloured light.

Lighting Requirements in Hotel Industry

Proper design of lighting is one of the key factors for the successful functioning of the hotel industry. While design should have an eye on the energy economy as a whole, proper levels and duration of lighting must be maintained throughout. The principal objectives of lighting may be listed as follows:

1. To provide good working conditions to prevent strain and fatigue to the personnel.
2. To create a proper ambience.
3. To help people know the directions and destinations by use of proper lighting signs.
4. To help maintain safety standards.
5. To enhance security in the premises.

6. To selectively attract people to some focal points.

Terms Associated with Lights

1. Luminous flux (lumen = lm) This is the total light output of a light source (lamp). The luminous flux is of particular importance, because it is the quantity that is used to describe the "brightness" of a light source. For example, a 100 watt filament lamp would produce about 1,360 lumen. A 30 watt fluorescent lamp would produce about 1,600 lumen. The luminous flux is therefore the light output by the lamp.

2. Luminous intensity I (candela = cd) Luminous intensity is the light flux of a lamp or light bulb emitted in a specific direction. The type of reflector of a lamp or luminaire determines the light intensity distribution and is frequently shown as a light intensity distribution curve.

3. Illumination E (lux = lx = lm/m²) Illumination is divided by the light flux of a lamp into lumen, where one lux is an illumination of one lumen per square metre. The light of a full moon would provide an illumination of about 1 lux, good workplace lighting about 1,000 lux, and on a sunny day outdoors, the illumination intensity would be about 100,000 lux.

4. Luminance L (cd/m²) Luminance is a measure of the brightness of an illuminated surface. In addition to the luminous intensity, the reflection factor of the surface is also decisive.

5. Luminous efficiency The luminous efficiency (Lumen per watt) is a measure of the efficiency of lamps. The more light (lumen) obtained for the amount of power (watt) input, the less the costs (Euro) are and the better the economy. Whilst tungsten-halogen lamps provide about lumen per watt, this can about 75 lumen per watt with fluorescent lamps.

6. Luminous colour and colour temperature The luminous colour of a light source is described by the colour temperature. With filament lamps this is about 2,700 Kelvin (K) and with fluorescent lamps this is above 6,000 K. A light source with 3,000 K has a larger proportion of red, a light source with 6,000 K has a larger proportion of blue.

7. Colour Temperature: It is the temperature rating of a bulb in degrees Kelvin representing the warmth/coolness effect of the bulb.

Types of Lighting

Lighting are of 4 types. They are as follows

- a. Direct lighting
- b. Indirect lighting
- c. Semi direct lighting
- d. Diffused lighting

Direct lighting - Direct lighting is where the light is directed straight from the bulb into the room. It is the type that is produced by most table & floor lamps . It is the light which shines directly to the room area.

Indirect lighting - It is where all lights are directed on to the ceiling or wall from which is reflected back into the room.

Semi direct lighting - It is where some of the lights are directed into the room & some is allowed to be directed reflected from the ceiling.

Diffused lighting - It is where the bulb or the light source is completely enclosed & lights are diffused through a translucent shade or material.

NATURAL LIGHT FOR HOTEL LIGHTING

Though only 10% of normal day light enters a room, it is still brighter than artificial lights. Colours look different in day light compared to artificial lights.

Advantages of day light:

- It costs nothing except the cost of providing windows.
- It is natural
- Because it varies according to the time of the day & passing clouds, it is the soothing & kinder to the human eye.
- Disadvantages of day light:
- Daylight doesn't uniformly illuminate a room
- Daylight is not available throughout the day.
- Brilliant sunshine fades some colour & rots some materials.
- The heat from the sun rays cause discomfort.

DIFFERENT TYPES OF LIGHTING USED IN VARIOUS AREAS OF HOTEL

a) Entrance & lobby- The area should be well lit & illuminated. The type of lighting that can be used are high power pendant lighting chandelier illuminated ceiling lighting wall & false ceiling. This is done to create an atmosphere of welcome & cheer so that the guest can feel warmth welcome.

b) Reception desk- This area should always be well lit but not very brightly The lighting can be done by light fittings or lights can be provided along the panel on top of the counter. This is done to attract the guest attention towards the counter when he enters the lobby.

c) Bars & lounges- In the lounge pools of soft lights from the table lamp, make this area welcome & attractive by creating small focal points.

d) Restaurant- These are often dimly lit to create an atmosphere but there should be attractive pool lights.

e) Function rooms- Since these are used for variety purpose like conference meeting exhibition private parties, etc, good general lighting should come from all the ceiling.

f) Rooms- They should be well lit but not brightly. Generally, lights are not required in the room because separate lighting is provided in different places of the room.

g) Bathroom – Bathroom should be properly illuminated. The lighting used should be vapor proof & should have covering.

h) Stair case- Stair cases should be well illuminated to prevent accident. The lighting used in the different places along the wall, below the handrail, or overhead lighting along the wall.

i) Corridor- The area should be provided with enough lighting & should not be dark. The lighting should be enough to see the room no on the doors.

j) Parking Area – Outdoor car parks require bright night-time lighting to help drivers find their way and recognise other moving vehicles promptly while inspiring trust in individuals walking to or from their vehicles at night. Security personnel require adequate light to be able to discern suspicious activity through their surveillance cameras.

k) Emergency Lighting - Emergency lighting is normally required to operate fully automatically and give illumination of a sufficiently high level to enable all occupants to evacuate the premises safely.

TYPES OF ARTIFICIAL SOURCES OF LIGHT

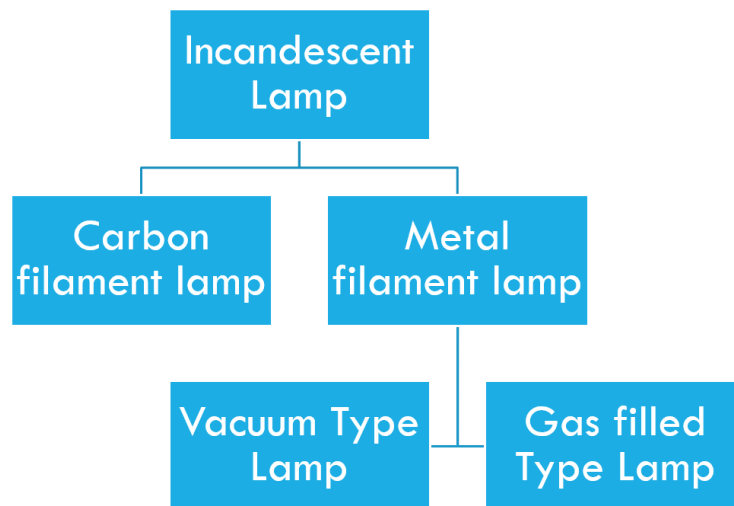

Incandescent Lamp

Carbon Filament Bulb – It is made up of a glass bulb having a fine carbon filament wound in a spiral shape. Rarely used now as it produces more heat in comparison to light and consumes a lot of electricity.

Metal Filament Lamp – This lamp consists of fine metallic wire either straight or coiled, which is called the filament. The filament is made up of tungsten metal and hence it is also referred to as tungsten lamp. These lamps are available in to varieties namely, vacuum type and gas filled type.

Vacuum Type – The lamp has vacuum and a filament in shape of a net. Of this type some special types are frequently used in hotel guests' rooms.

1. Pigmy lamp
 2. Candle lamp
 3. Night lamp
-

These lamps are generally made between 0 to 25 watts. Pigmy and candle lamps are available in a number of colours. Night lamps are also called 0 watt lamps and are used to provide dim light while sleeping at night. They may be clear or milky type.

Gas filled lamps – In order to raise the working temperature of a filament the bulbs are filled with an inert gas i.e. Argon, Nitrogen etc. instead of vacuum.

Gas Discharge Lamp

In gas discharge lamps, the light is not emitted by a filament, but a discharge produced in the gas, filled at low pressure emits light. There are two types of gas discharge lamps;

1. Sodium Vapour Lamp: It produces bright glaring light. Its main parts are: Glass tube, electrodes, sodium and argon gas, transformer and capacitor. It is made in the form of U shape, protected in a double walled vacuum flask to protect it from changes in atmospheric temperature. It produces yellow colour light. Usually used for street and road lighting.

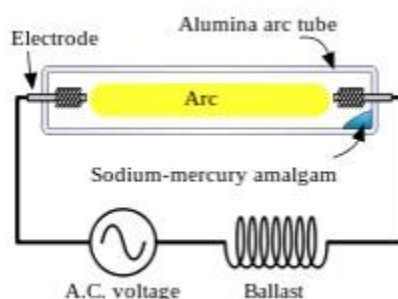

2. Mercury Vapour Lamp: A mercury vapour lamp is filled with mercury vapours (gas) instead of sodium and argon. Its working principle is identical to that of sodium vapour lamp. These lamps emit different coloured lights when different activators are added.

Gold: White bluish light

Silver: Bluish light

Copper: Greenish light

Manganese: Deep yellowish light

3. Neon Lamp: They are used for signs and decoration. Different gases are filled so as to obtain different colours:

Orange colour: Neon gas

Blue colour: Neon and Argon gas

Green colour: Yellow glass, neon gas with mercury

Yellow colour: Yellow glass, helium gas

Fluorescent Tube

A fluorescent tube is a 'low pressure' mercury discharge tube. Inside of the tube is coated with a fluorescent material. These are known as Phosphors.

The tube contains mercury and a small amount of argon gas.

Two tungsten electrodes are sealed at the ends of the tube.

A choke produces a high starting voltage for warming up the electrodes.

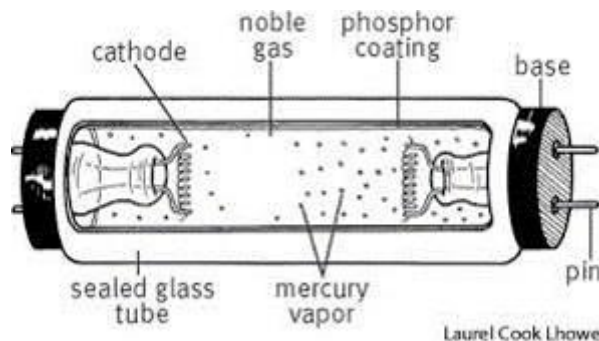

CFL (Compact Fluorescent Lamp)

A compact fluorescent lamp (CFL), also called compact fluorescent light, energy-saving light, and compact fluorescent tube, is a fluorescent lamp designed to replace an incandescent light bulb; some types fit into light fixtures designed for incandescent bulbs. The lamps use a tube which is curved or folded to fit into the space of an incandescent bulb.

LED (Light Emitting Diode)

It is an electronic light source. LED is based upon semiconductor diode. CFL's are being replaced by LED's due to the following advantages.

1. Longer Lifetime.
2. Smaller Size
3. Silent and instant operation and more efficient.
4. Emits a bright white light, last for 10,000 hours approx.
5. Uses fraction of electricity as compared to incandescent bulbs.
6. Boon in fighting against global warming.

Solar Lamps

- A solar lamp also known as solar light or solar lantern, is a lighting system composed of an
- LED lamp, solar panels, battery, charge controller and there may also be an inverter.
- The lamp operates on electricity from batteries, charged through the
- use of solar photovoltaic panel.
- Solar lamps use renewable energy with infinity supply which is cheaper than standard lamps.
- However, solar lamps may have higher initial cost, are weather dependent.
- Solar lamps are used for outdoor lighting.

Application of Lamps in Hotels

LIGHT SOURCE	APPICATION
Ordinary Lamps	Living Room, Study Room, General Purpose
Halogen Lamps	Street Lighting
Fluorescent Lamps	Living Room, Study Room
CFL	Corridors, Washrooms etc.
LED	Offices
Sodium Vapour Lamps	Outdoor lights, Street Lights
Mercury Vapour Lamps	Street Lights
Metal Halides	Multi Purpose Playing Courts, Commercial space etc.

Colour – Temperature Requirement

What is colour temperature?

Colour temperature is a way to describe the light appearance provided by a light bulb (lamp). It is measured in degrees of Kelvin (K) on a scale from 1,000 to 10,000.

Typically, commercial and residential lighting application Kelvin temperatures fall somewhere on a scale from 2000K to 6500K.

A light bulb's (lamp's) colour temperature lets us know what the look and feel of the light produced will be.

	2000-3000K	3100-4500K	4600-6500K
Color Temperature (KELVIN)	2000K - 3000K	3100K - 4500K	4600K - 6500K
Light Appearance	Warm White	Cool White	Daylight
Ambience	Cozy, calm, inviting, intimate	Bright, vibrant	Crisp, invigorating
Best for	Living room, kitchens, bedrooms, bathrooms, restaurant/commercial ambient lighting, decorative outdoor lighting	Basements, garages, work environments, task lighting, bathrooms	Display areas, security lighting, garages, task lighting

External Lighting

- Building
- Lawns
- Approach Road
- Swimming Pool
- Multi-Purpose Games Court
- Parking Area
- Open Air Restaurants